



# Banner GUIDELINE

Format:	final format or scaled
Resolution:	ratio 1:1, 96-150 dpi ratio 1:10, 300 dpi
Bleed:	3 mm (mind the ratio)
Crop marks:	no
Overprint:	deactivated
Fonts:	embedded or converted to paths
Do not use:	alpha channels, clipping paths, masks
Data format:	from PDF/X-3. With transparencies, gradients, raster, drop shadow necessarily in PDF/X-4
File upload:	Printing data can be uploaded in the online shop.
Color mode:	CMYK
Color profile:	ISO Coated v2, Coated Fogra 27/39
Color space:	printing is done in CMYK. RGB and special colours such as Pantone and HKS will be converted to CMYK and color deviations occur.
Andruck / Proof:	We recommend a <a href="#">proof</a> in advance if color reproduction is of high priority.
Notes:	Print and production tolerance is 0,25 %. Depending on file format and print material colour deviations may occur during printing.

---

## Notes

### Special confection

Please describe during the ordering process in the field "comment on order". Your request will be checked and a possible surcharge will be communicated before production starts. The shipping date may be postponed accordingly. You are welcome to send an enquiry in advance to [info@werbecenter-berlin.de](mailto:info@werbecenter-berlin.de)

In the case of special confection the standard confection will not apply.

### Shipping

Banners above **100 cm** length will be folded.

Rolled shipping is possible after checking and for an additional charge.



# Banner - up to 310 cm (short side)

## Example sketch

### Printing width and division of the banner

Up to a width of **310 cm** and length of up to **4,500 cm (45 m)** you will receive your banner in one piece. If the shorter side of the banner is over 310 cm, it will be divided.

The division will be made in equal parts (as far as possible) and welded together. The division will be done **vertically**. Please consider when ordering.

Reinforced hem **from 2 m<sup>2</sup>**

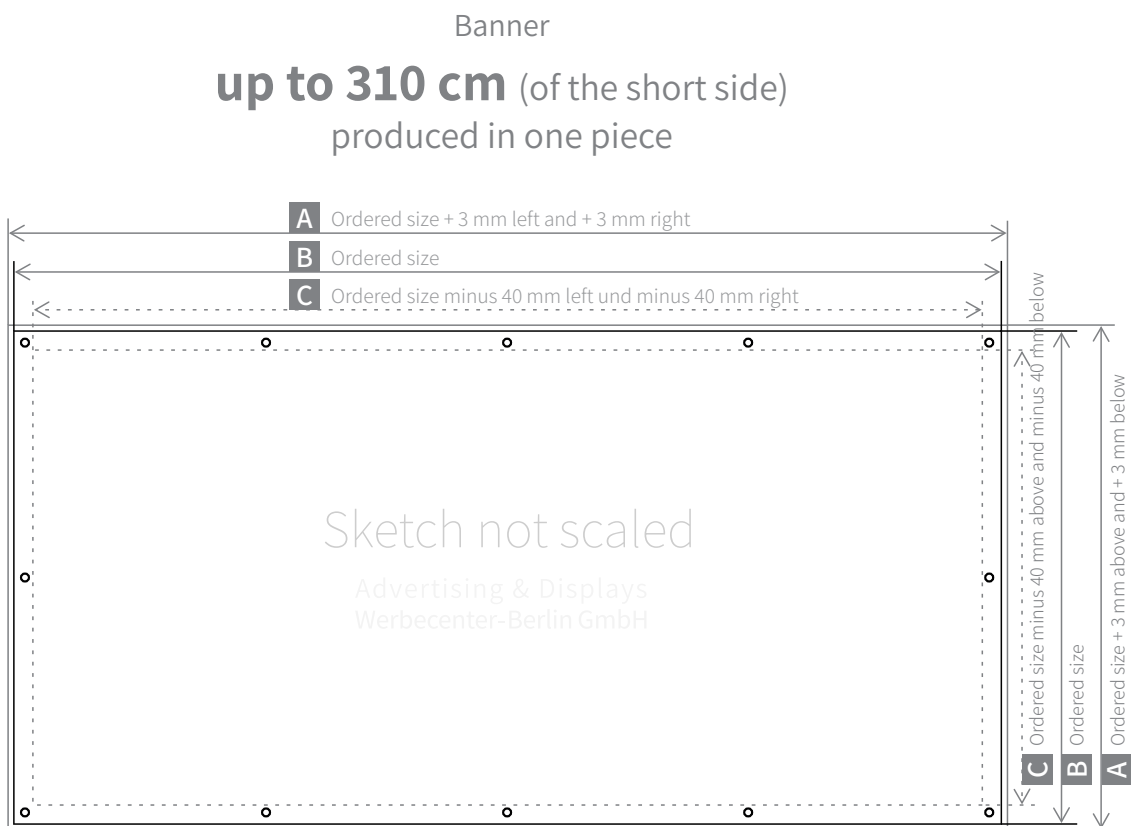

- A = File format
- B = Final format after confection
- C = Safe area for logo and text (recommended)

# Banner - over 310 cm (short side)

## Example sketch

### Printing width and division of the banner

Up to a width of **310 cm** and length of up to **4,500 cm (45 m)** you will receive your banner in one piece. If the shorter side of the banner is over 310 cm, it will be divided.

The division will be made in equal parts (as far as possible) and welded together. The division will be done **vertically**. Please consider when ordering.

Reinforced hem **from 2 m<sup>2</sup>**

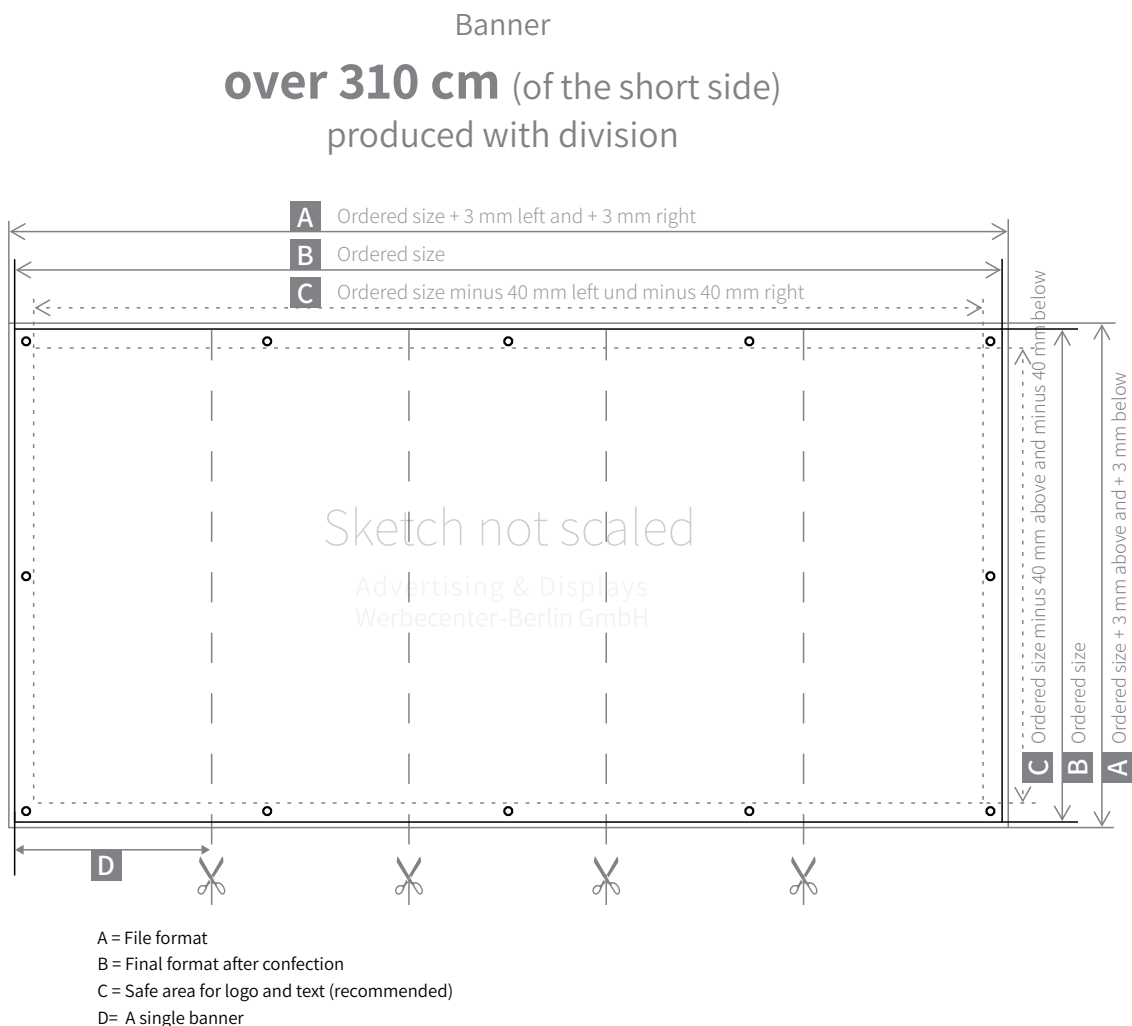

# Banner - Manufacturing custom sizes

## Example sketch

### Banner with eyelets and reinforced hemstitch from 2 m<sup>2</sup>

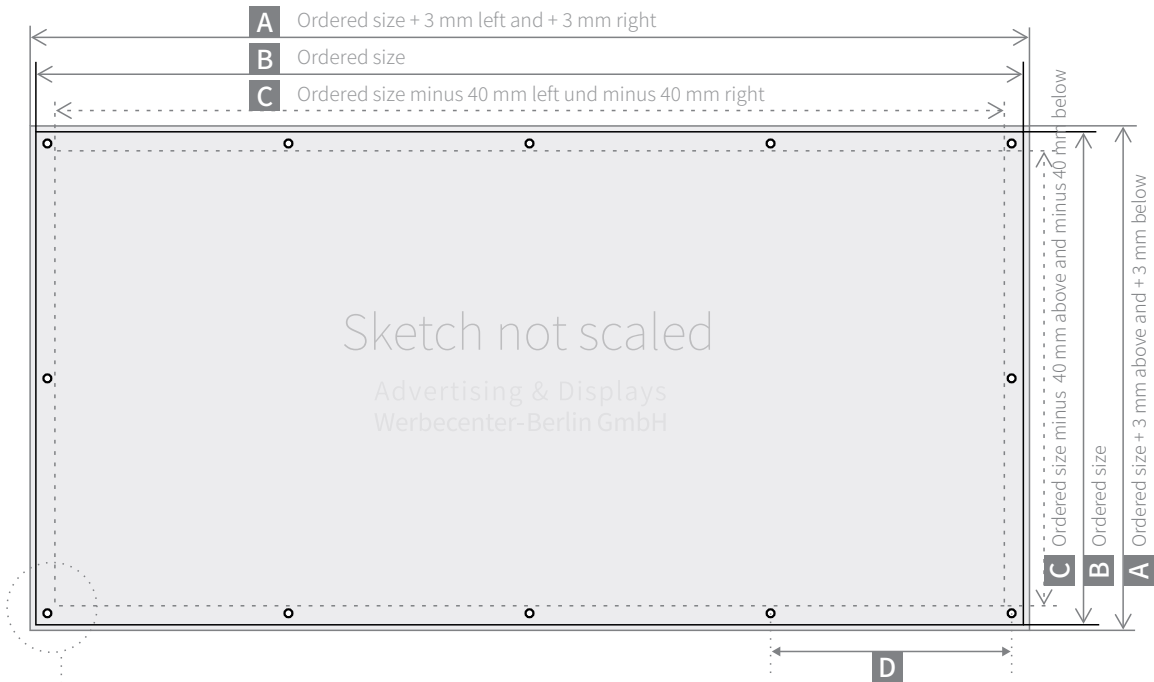

- A = File format
- B = Final format after confection
- C = Safe area for logo and text (recommended)
- D = The eyelets are placed **approx. every 50 cm**.  
Depending on the size of the banner the distances might be shorter.  
Hem from **2 m<sup>2</sup>**

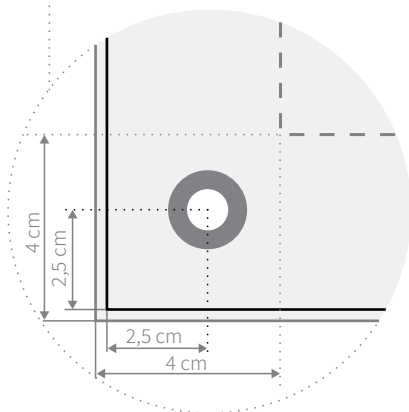

### with hem and eyelets

The eyelets are placed **approx. every 50 cm**. Depending on the size of the banner the distances might be shorter.

#### 4 cm Safty area:

In this area the eyelets will be set. We recommend a safety space for text, logos or other important elements of **4 cm** from all sides.  
All data apply to the scale 1:1.



# Banner - Manufacturing custom sizes

## Example sketch

Banner  
cut only  
without hemstitch and eyelets

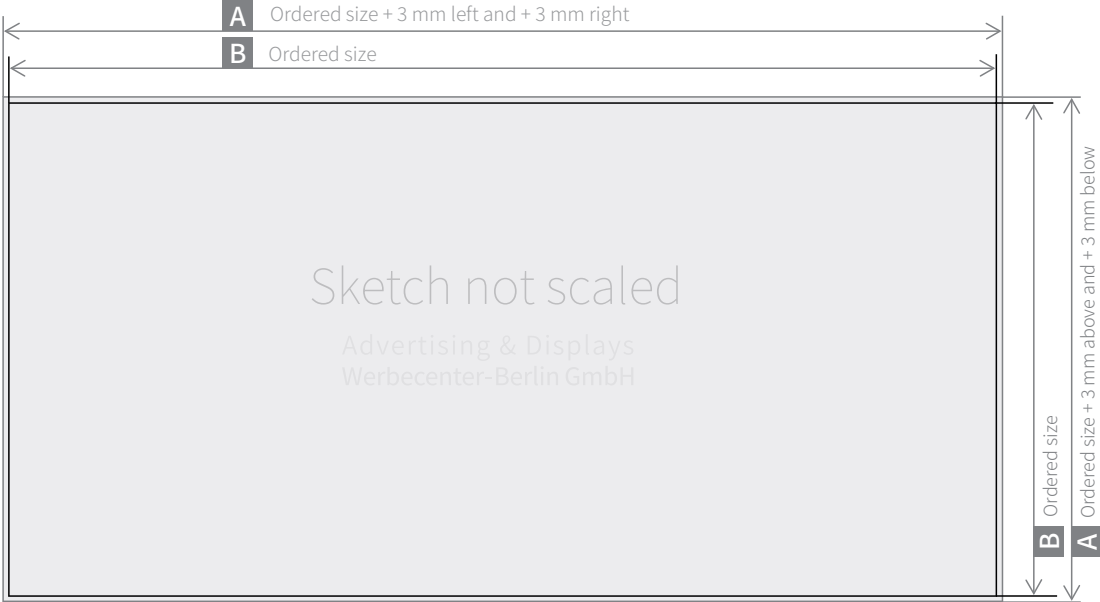

A = File format  
B = Final format after confection

# Banner - Manufacturing custom sizes

## Example sketch

### Banner with differing eyelets and reinforced hemstitch (from 2 m<sup>2</sup>)

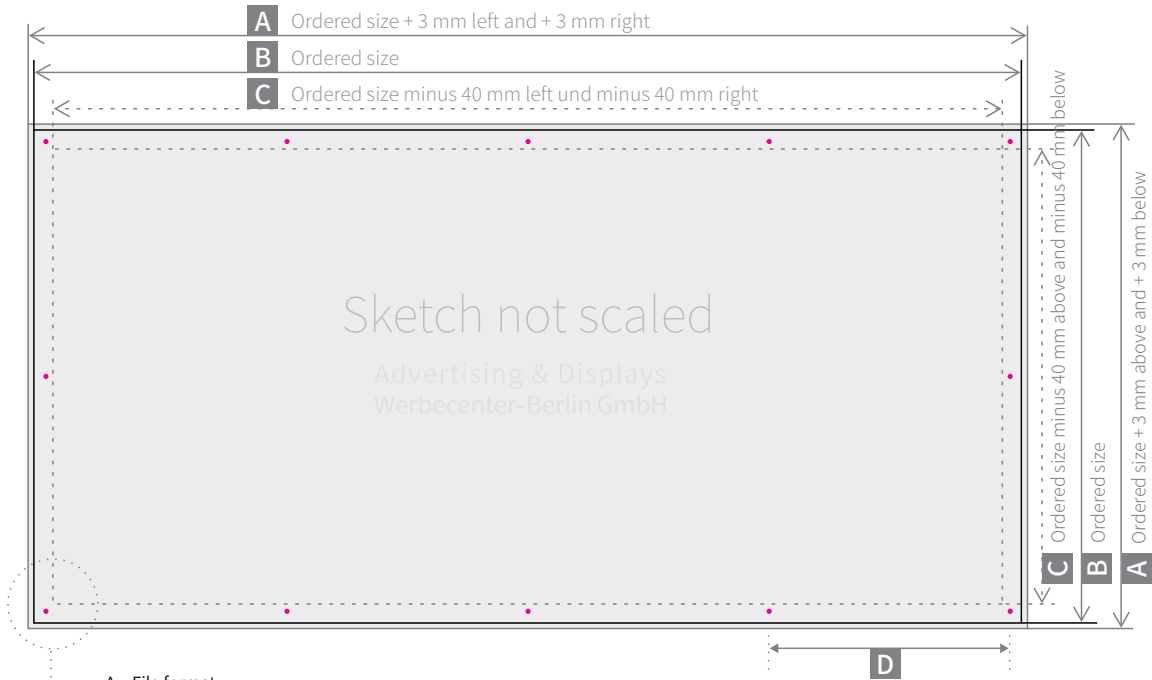

- A = File format
- B = Final format after confection
- C = Safe area for logo and text (recommended)
- D = The eyelets are placed **approx. every 50 cm**.  
This distance can also be shorter, depending on the size of the banner.  
Hem from **2 m<sup>2</sup>**

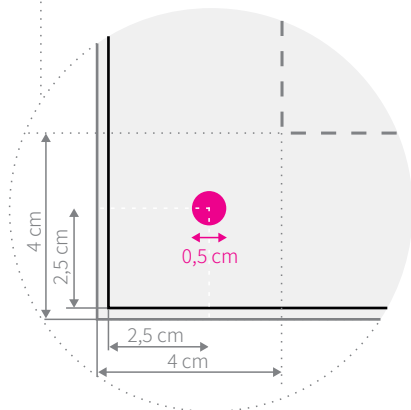

### with differing eyelets and reinforced hemstitch (from 2 m<sup>2</sup>)

If you would like the eyelets to be made up differently, please create eyelet markings (Ø 0.5 cm) in 100% magenta\* as a spot colour at the desired position directly in the print file.

**Important:** Make sure label the special colour as "Eyelets".  
The centre of the eyelet circle has to be positioned **2.5 cm** from the edge.

(\* If your motif is magenta or red you are welcome to use 100% cyan as the colour value).

# Banner - Manufacturing custom sizes

## Example sketch

### Banner with hemstitch

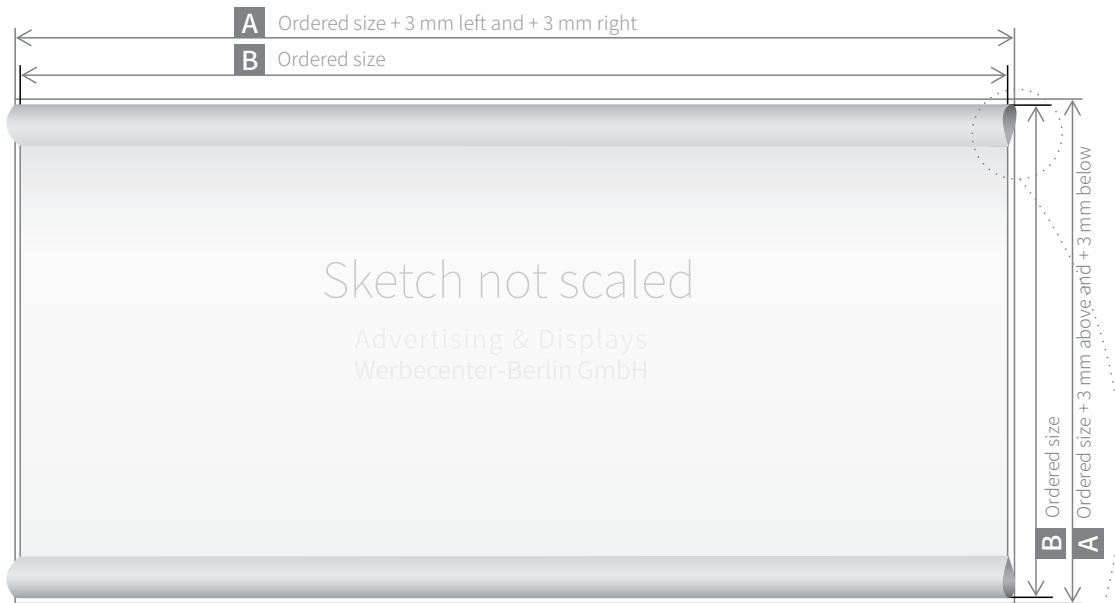

### with Two opposite sides

The sketch shows a banner with two hemstitches. Hemstitch is possible on one side or two opposite sides. The remaining sides will be cut only and will be produced **without eyelets and without reinforced hem**.

**Rolled shipping** is recommended and available for an additional charge. Please note the request in the comments field during the order process. We will contact you before production starts.

